

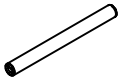









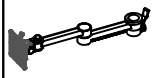

MODEL : P-QS-S
P-QS-W
P-QS-B

A	B M6*25	C 4 mm	D	E
				
x1	x3	x1	x2	x1
F 2.5 mm	G M4*10	H 3 mm	I 2 mm	
				
x1	x4	x1	x1	

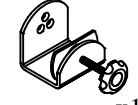
OPTION A./

J	K
	
x1	x1

OPTION B./

L	M EVA PAD	N M10*90
		
x2	x1	x1



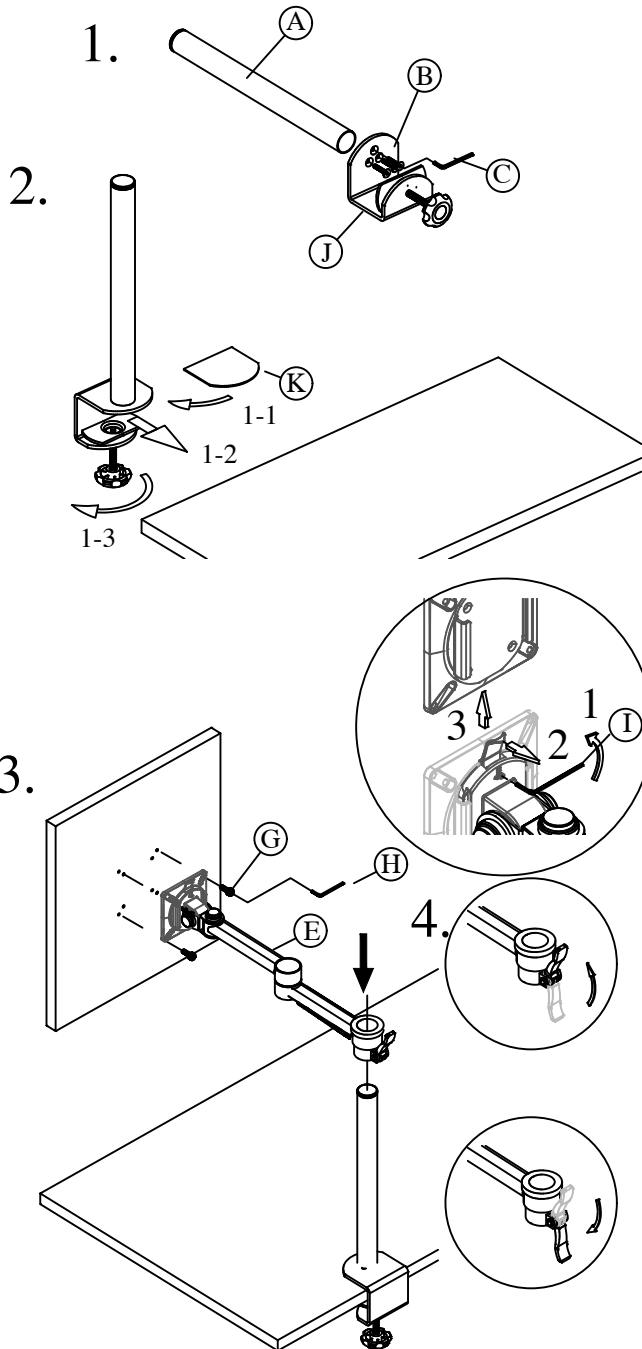

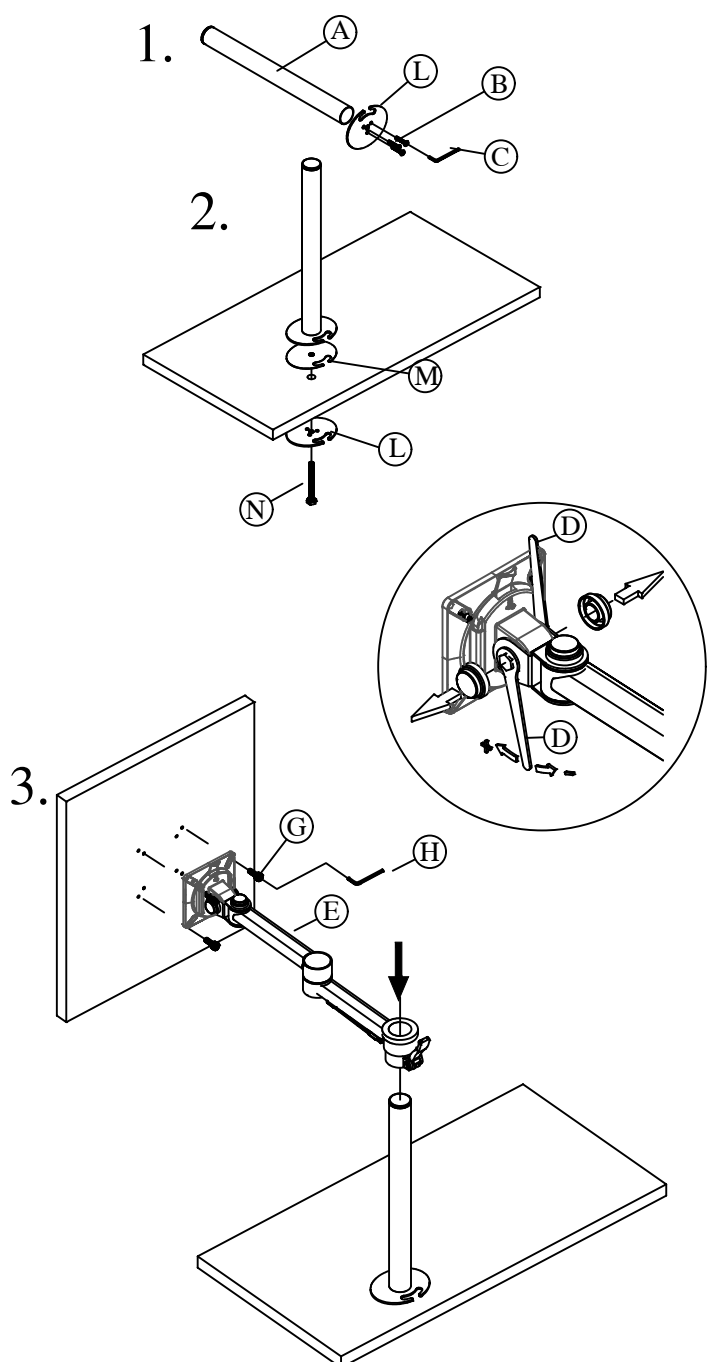

OPTION A./

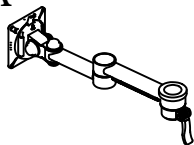

OPTION B./

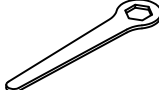

MODEL : P-QA-S
 P-QA-W
 P-QA-B

 X1	 X4	C 2 mm  X1	D 3 mm  X1
		E  X2	F 2.5 mm  X1

