

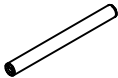









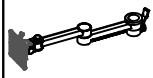

MODEL : P-QS-S
P-QS-W
P-QS-B

| | | | | |
|---|---|---|---|---|
| A | B M6*25 | C 4 mm | D | E |
|  |  |  |  |  |
| x1 | x3 | x1 | x2 | x1 |
| F 2.5 mm | G M4*10 | H 3 mm | I 2 mm | |
|  |  |  |  | |
| x1 | x4 | x1 | x1 | |

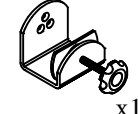
OPTION A./

| | |
|---|---|
| J | K |
|  |  |
| x1 | x1 |

OPTION B./

| | | |
|---|---|---|
| L | M EVA PAD | N M10*90 |
|  |  |  |
| x2 | x1 | x1 |

OPTION A./

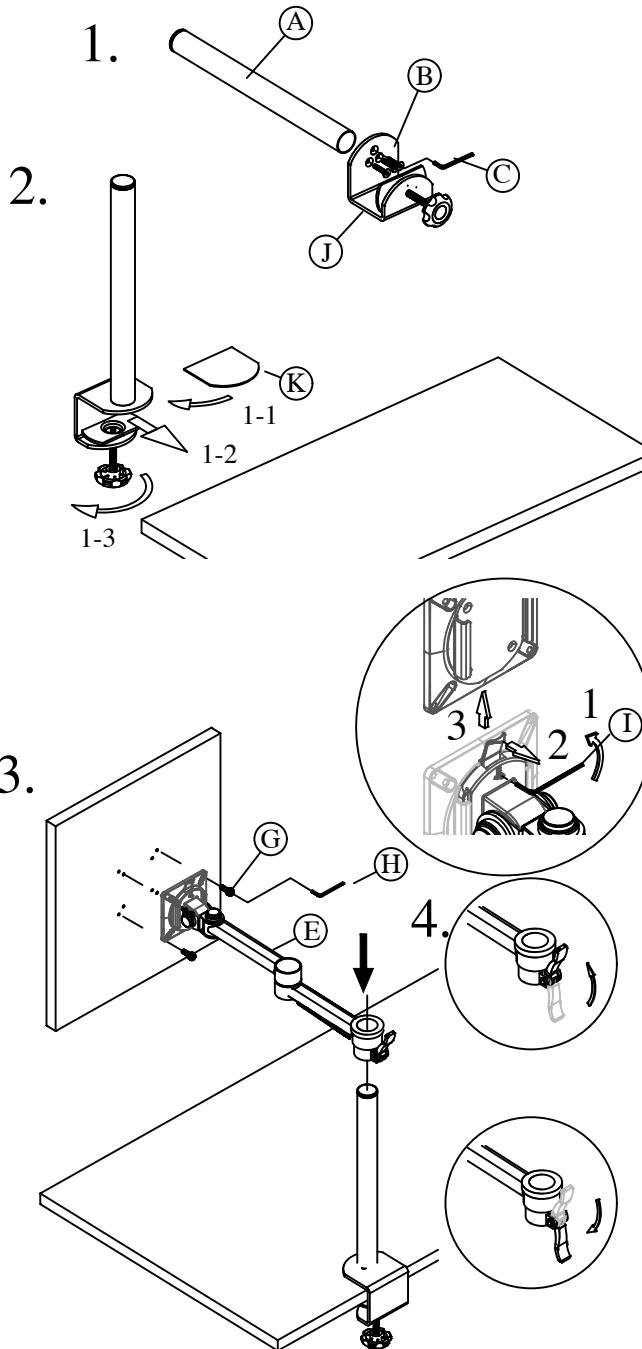

OPTION B./

