

# ELEVAR

CRANK+ / 2 LEG

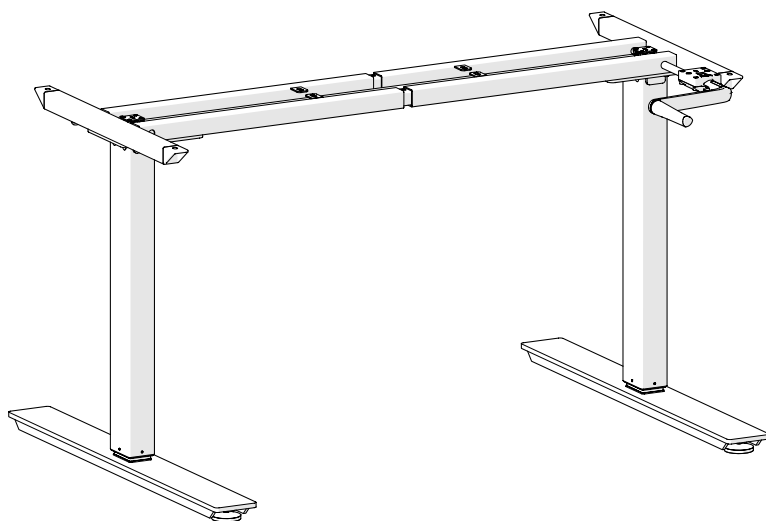

## 1. Packaging

### 1.1 Part Check List



Leg (2 Pcs)

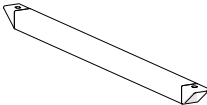

End Pipe (2 Pcs)

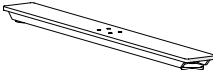

Feet (2 Pcs)

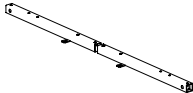

Top Frame (2 Pcs)



Gear Connection (1 Pcs)

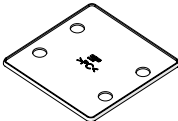

Plate (2 Pcs)



Handle (1 Pcs)



M6x25 (8 Pcs)

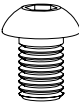

M8x12 (12 Pcs)

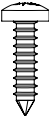

ST 4.8x19 (10 Pcs)



M5x35 (4 Pcs)



ST 4.8x38 (4 Pcs)

## 2. Assembly

Parts displayed above may vary, based upon Frame Configuration



### Torque Guide

- M6 Screw's max torque = 6nm
- M8 Screw's max torque = 6nm
- M10 Screw's max torque = 6nm
- Tapping screws hand tightening only (**Do not use power tools!**)

### 2.1 Assembly Step by Step

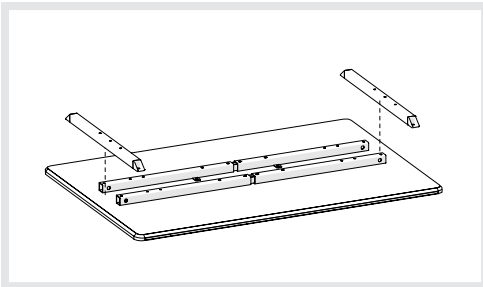

#### Step 1

Assembly the Top Frame & End Pipe as illustrated above.

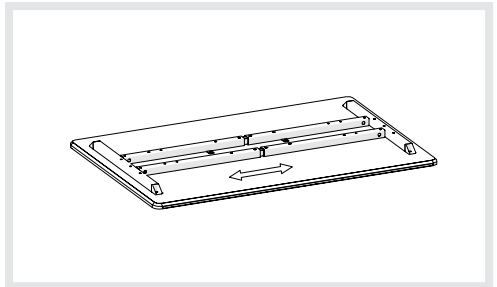

#### Step 2

Adjust the Top Frame to the suitable length.

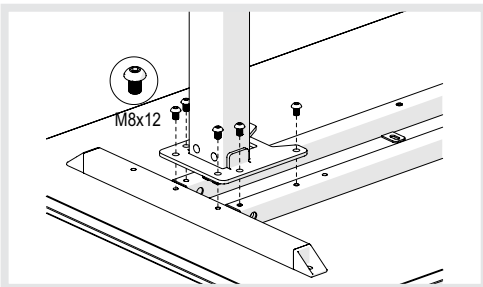

#### Step 3

Assembly the Top Frame, End Pipe and Leg as illustrated above. Please refer to **Page 3 Torque Guide**.

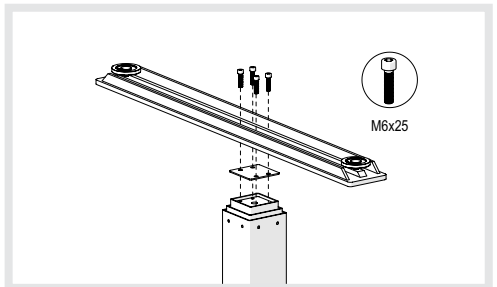

#### Step 4

Mount the Feet to the Leg as illustrated above. Please refer to **Page 3 Torque Guide**.

## 2. Assembly

### 2.2 Assembly Step by Step

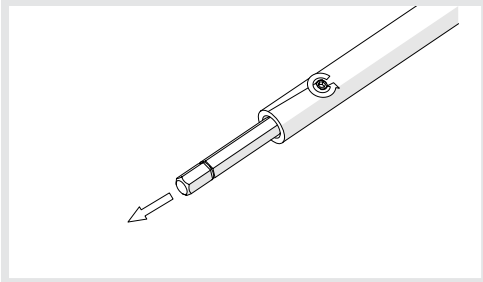

#### Step 5

Adjust the Gear Connection to the suitable length.

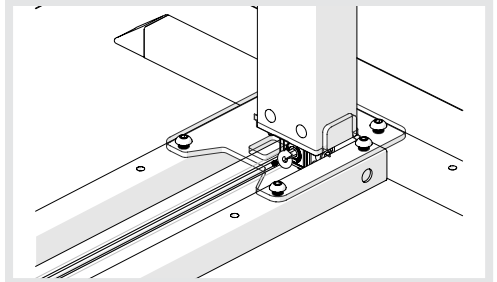

#### Step 6

Mount the Gear Connection to the Leg as illustrated above.

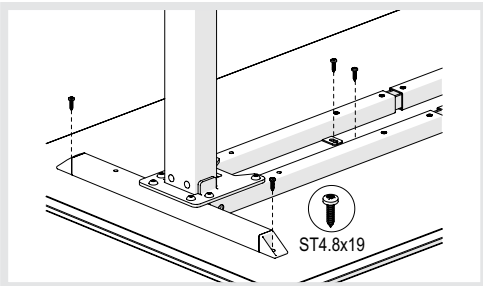

#### Step 7

Mount the Frame to the Table top as illustrated above. Please refer to [Page 3 Torque Guide](#).

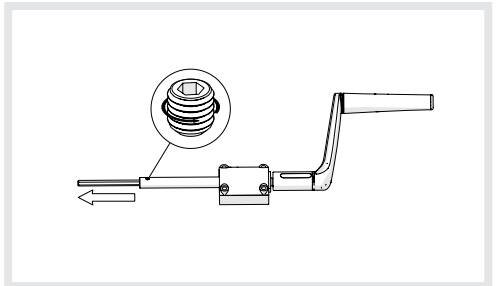

#### Step 8

Use the suitable Gear Connection for handle and adjust it to the suitable length.

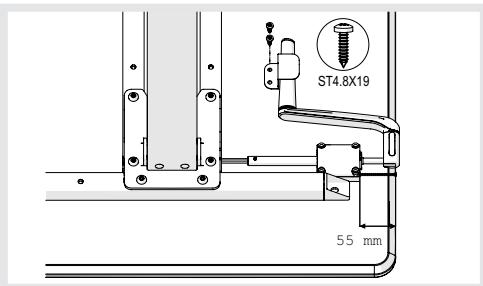

#### Step 9

Measure the Handle location as illustrated above. Handle can be mounted either left or right side.

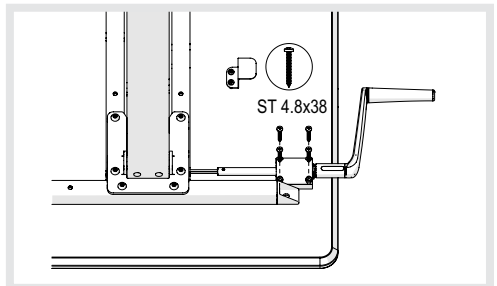

#### Step 10-1 (use screws ST 4.8X38)

Mount the Handle to the Table top as illustrated above. Please refer to [Page 3 Torque Guide](#).

## 2. Assembly

### 2.3 Assembly Step by Step

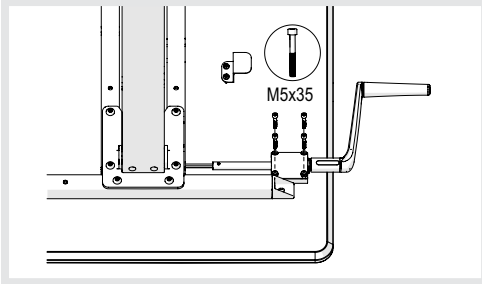

#### Step 10-2 (or use screws M5X35)

Mount the Handle to the Table top as illustrated above. Please refer to **Page 3 Torque Guide**.

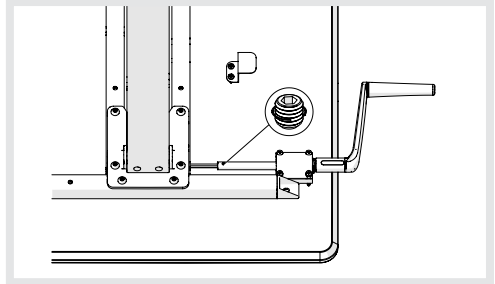

#### Step 11

Tighten Gear Connection in handle as illustrated above.

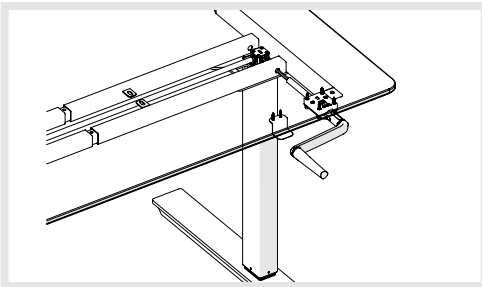

#### Step 12

Now you can use your height adjustable frame.